



AGENDA ITEM 6  
GOLDEN GATE BRIDGE, HIGHWAY AND TRANSPORTATION DISTRICT

MERVIN C. GIACOMINI, P.E.  
DISTRICT ENGINEER

Feb 16, 1999  
For: Mar 05, 1999

TO: Building & Operating Committee/  
Committee of the Whole

FROM: Mervin C. Giacomini, District Engineer

SUBJECT: **GOLDEN GATE BRIDGE, SUICIDE DETERRENT - REVIEW OF  
DESIGN ALTERNATIVES (INFORMATION/ACTION)**

The Board, by Resolution No. 97-69, authorized Phase I of the Suicide Deterrent Project, which included the development and testing of a prototype using the Z-CLIP fencing system. By Resolution No. 97-106, the Board authorized acceptance of a proposal in the amount of \$46,840 from Z-CLIP International Fencing Systems to implement Phase I of the project.

Erection of the prototype in the Toll Plaza parking lot was completed on June 9, 1998. It consists of 125 feet of the Z-CLIP system attached to surplus bridge railing. The prototype was tested for effectiveness as a suicide deterrent and in addition was evaluated for aesthetics by the District's Architectural Advisory Committee, consisting of three eminent local architects.

The results of the testing and evaluation were presented to the Building and Operating Committee at its meeting of November 6, 1998, at which time the Committee declined to proceed with development of the Z-CLIP prototype and proposed that other barrier-type suicide alternatives be developed. Rus Haycock, Z-CLIP International's representative, offered to develop and evaluate alternative designs for a suicide deterrent. The Committee directed staff to contact Z-CLIP International regarding possible development of alternatives to the suicide deterrent presently available and report back to the Committee. The Board of Directors authorized \$10,000.00 for the development of suicide design alternatives by Z-CLIP International.

Staff has worked with Z-CLIP International to develop and evaluate alternative suicide deterrent designs. Rus Haycock of Z-CLIP International is here today to present the alternatives and evaluation of the alternatives. The alternatives that will be presented are:  
Alternative 1: The previously constructed prototype using curved posts and the Z-CLIP fencing system.

Alternative 2: A system of nets suspended on the outside of the pedestrian railing.

B&O/Committee of the Whole Agenda Item No. 6 for March 5, 1999/Page 2

- Alternative 3: A 10-foot-high wire mesh sectional fence on the sidewalk, similar to a system developed for the Clifton Bridge in England.
- Alternative 4: A barrier constructed below the sidewalk level outside the pedestrian railing utilizing the Z-CLIP system.
- Alternative 5: A barrier constructed at sidewalk level outside the pedestrian railing utilizing the Z-CLIP system.
- Alternative 6: A grid system made of steel rods mounted on curved posts similar to the system in use at the Eiffel Tower.
- Alternative 7: An eight-foot-high railing utilizing tensioned vertical rods.
- Alternative 8: Tensioned horizontal wires on straight support posts with a hinged top section spaced at 100-foot intervals. The top 2-foot section of the post is hinged to make climbing more difficult.

Architectural Advisory Panel Evaluation

On February 3, 1999, Z-CLIP International presented the above alternative designs to the District's Architectural Advisory Panel. The panel unanimously agreed that they preferred Alternative 8. They also recommended that a prototype be constructed for further evaluation.

Staff Evaluation

- Alternative 1 was previously rejected by the Architectural Advisory Panel.
- Alternatives 2, 4 and 5 are schemes that utilize a net or fence outside the existing pedestrian railing. They have less visual impact from the sidewalk or roadway than the Z-CLIP prototype Alternative 7; however, they share the following key disadvantages:
  - ◆ Difficult and costly to build and maintain.
  - ◆ Hamper maintenance activities and interfere with the traveling scaffolds on the bridge.
  - ◆ Marginally effective as a suicide deterrent and pose a hazard to District personnel attempting to apprehend an individual who has gone over the pedestrian rail.
- Alternative 3 is similar to the system developed for the Clifton Bridge, and Alternative 6 is similar to the system developed for the Eiffel Tower. Both have the disadvantage of negative visual impact in addition to the "fenced in" impression created by the curved posts that overhang the sidewalk.
- Alternative 7, developed by Anshen & Allen in 1971 and prototyped, has the greatest impact on the historic character of the bridge, in addition to being costly and having marginal effectiveness.
- Alternative 8, a fence system using tensioned horizontal wires on vertical posts spaced at 100-foot intervals adjacent to vertical suspender cables, has the least visual impact on the Bridge. It also represents the least costly alternative. It is anticipated that the hinged top section of the post would increase its effectiveness over that of

**B&O/Committee of the Whole Agenda Item No. 6 for March 5, 1999/Page 3**

**the Z-CLIP prototype.**

Following the Committee's review of the suicide deterrent design alternatives, should the Committee wish to proceed with one of the alternatives, the first step would be development of a prototype that will allow architectural evaluation and an assessment of the alternative's effectiveness as a suicide deterrent. In that regard, it is proposed that the District request a cost proposal for Z-CLIP International to develop the selected design alternative, construct a prototype and test the prototype.

NAS/tb

Attachments

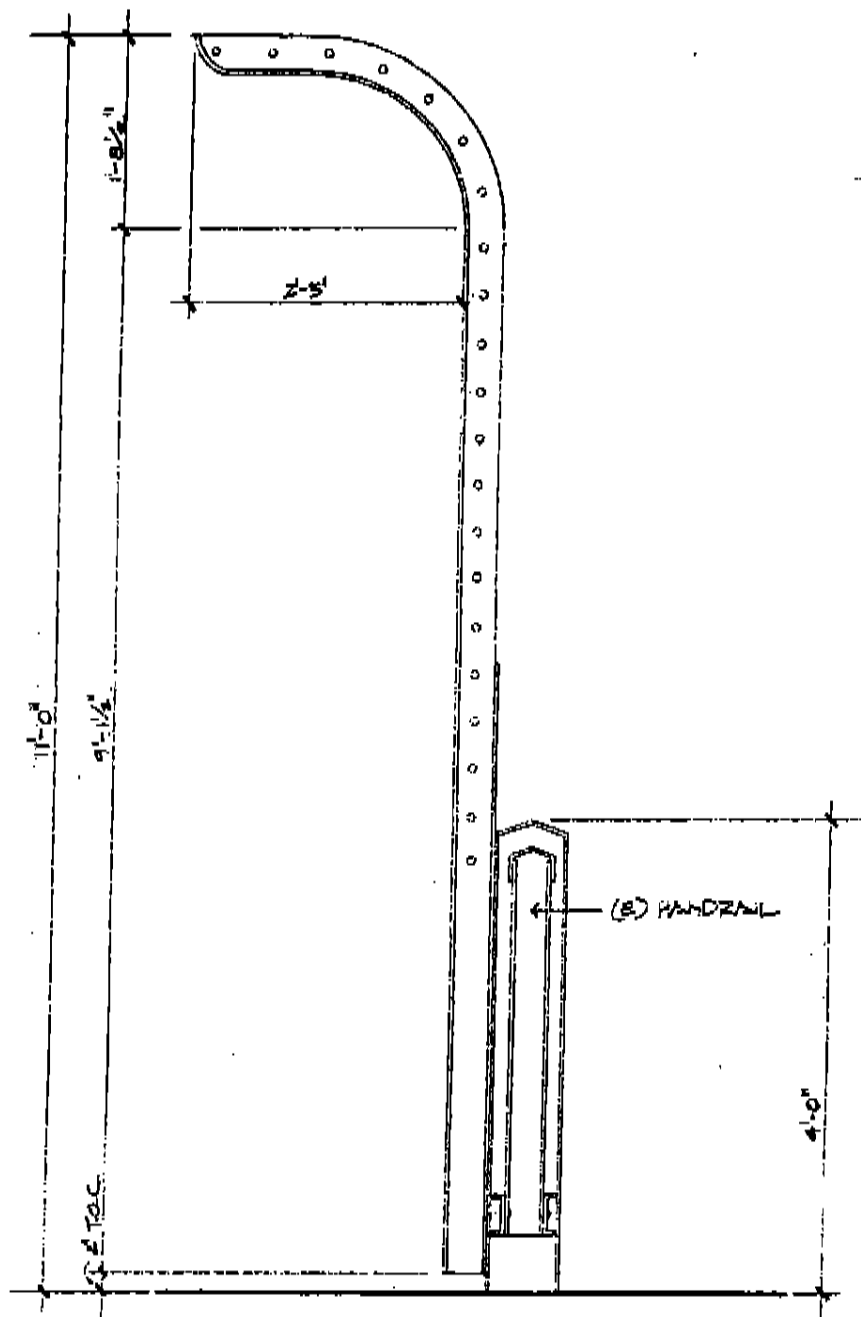

# 1. Z-CLIP PROTOTYPE

OUTRIGGER TO COLLAPSE AND  
ENTRAP JUMPER IN NET

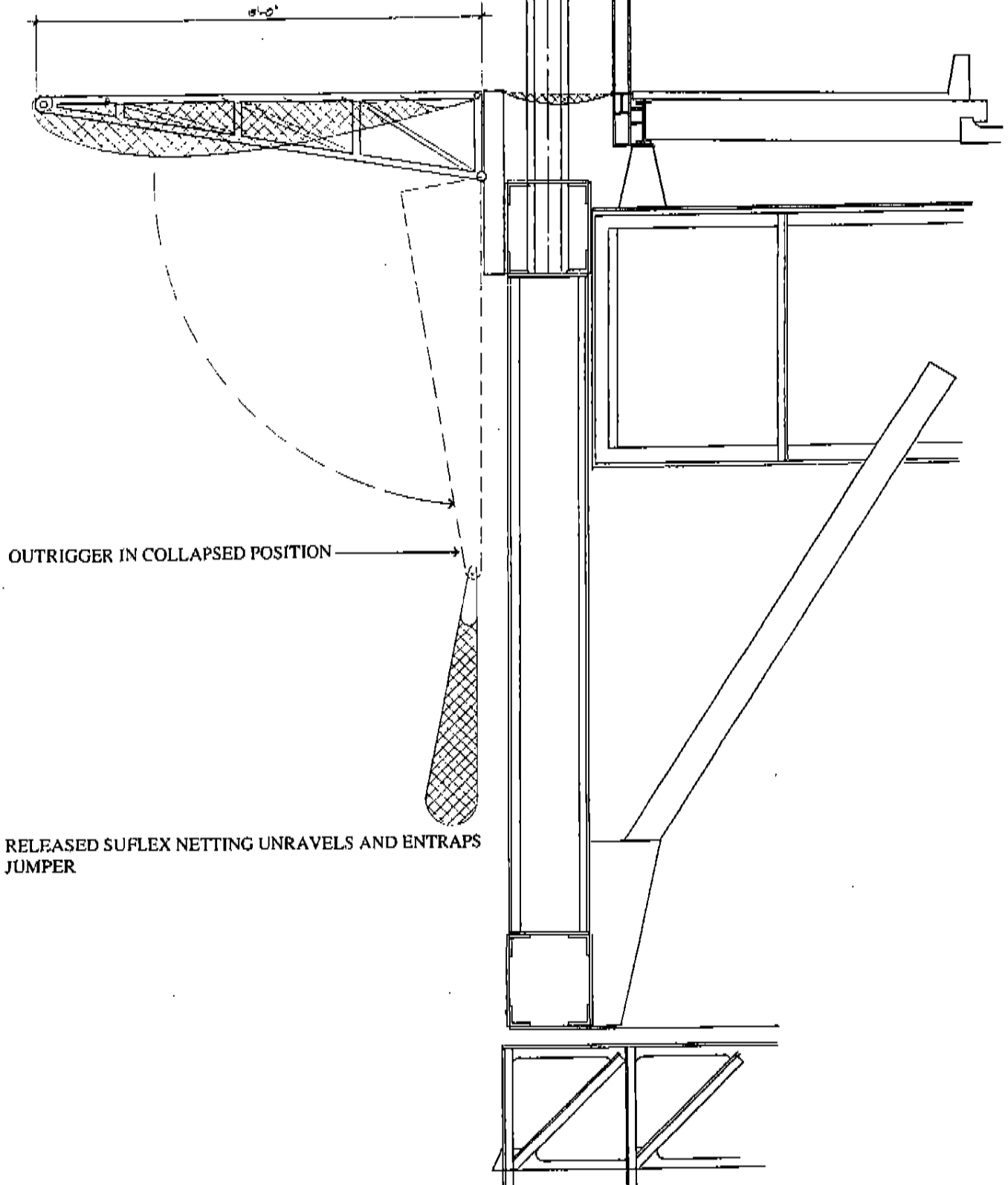

OUTRIGGER IN COLLAPSED POSITION

RELEASED SUFLEX NETTING UNRAVELS AND ENTRAPS  
JUMPER

2. NET

SCALE 1/2"=1'-0"

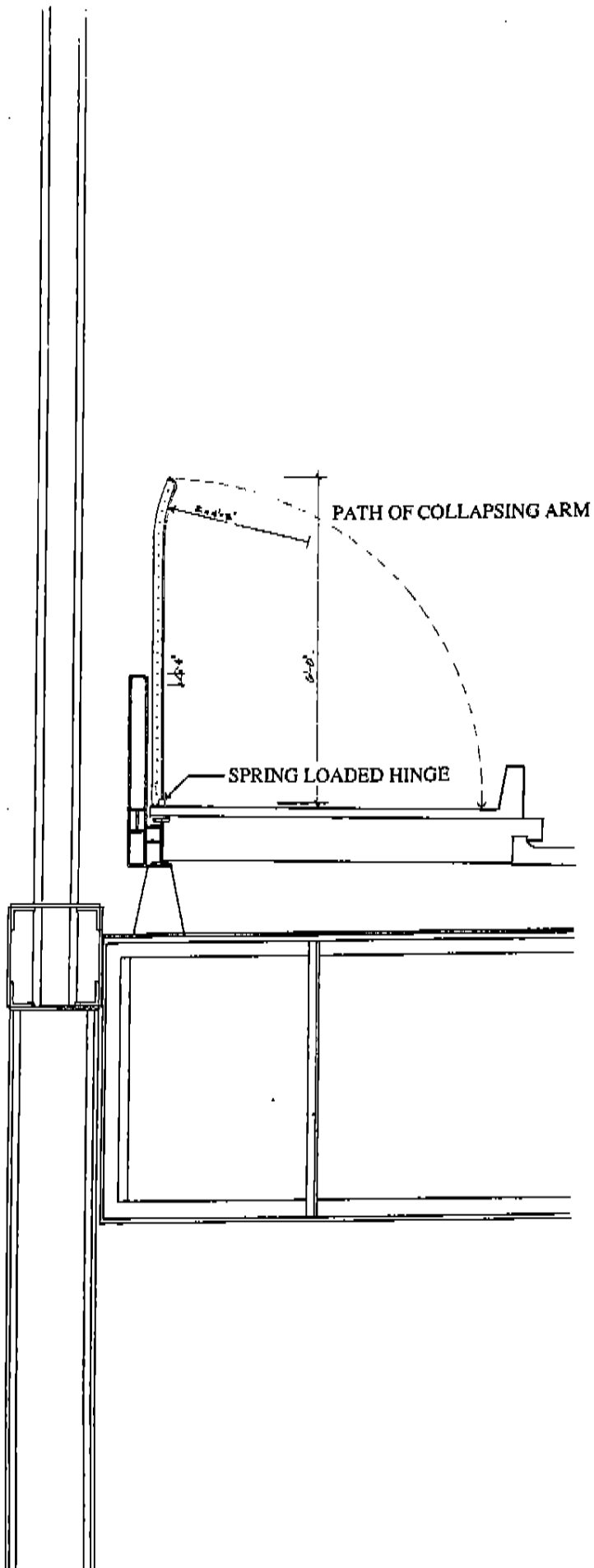

3. CLIFTON BRIDGE, ENGLAND

SCALE 1/2"=1'-0"

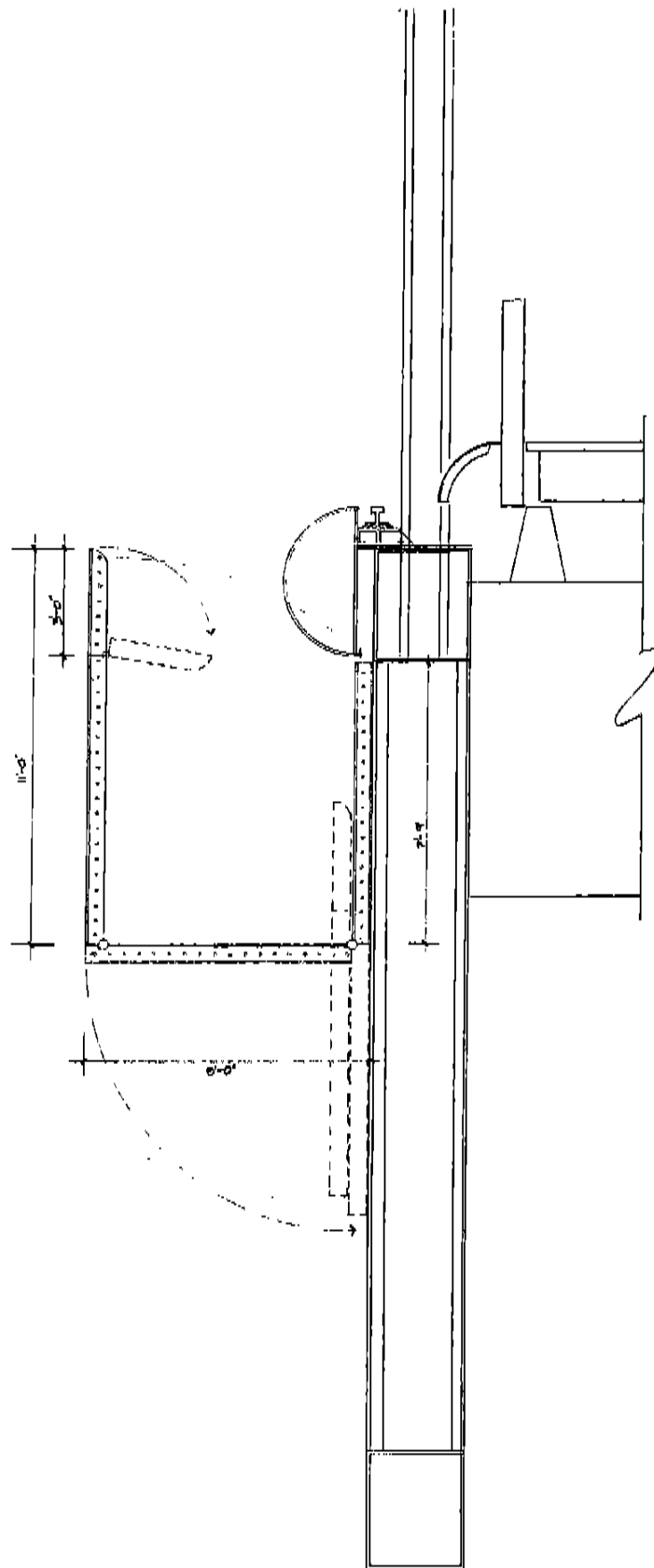

#### 4. Z-CLIP BELOW RAILING

SCALE 1/2"=1'-0"

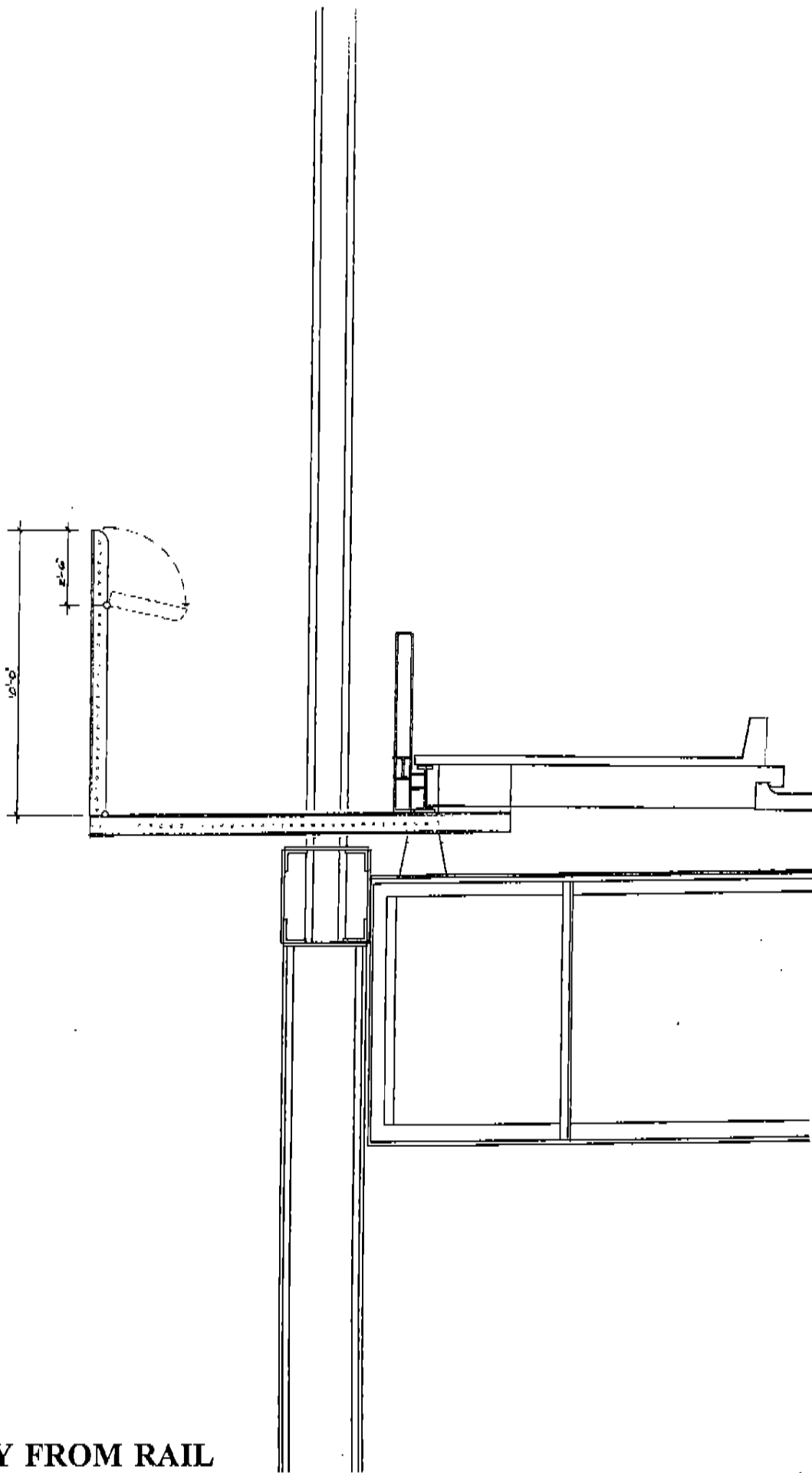

5. Z-CLIP AWAY FROM RAIL

SCALE 1/2"=1'-0"



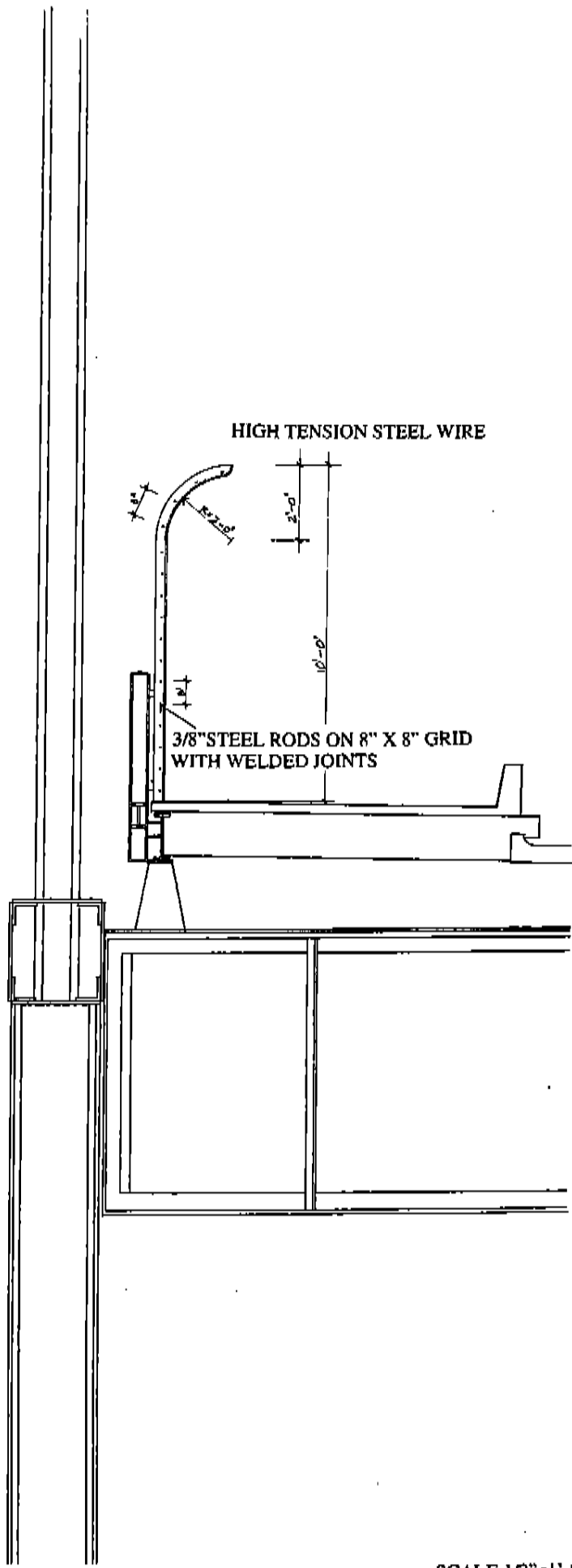

**6. EIFFEL TOWER MODIFIED**

SCALE 1/2"=1'-0"

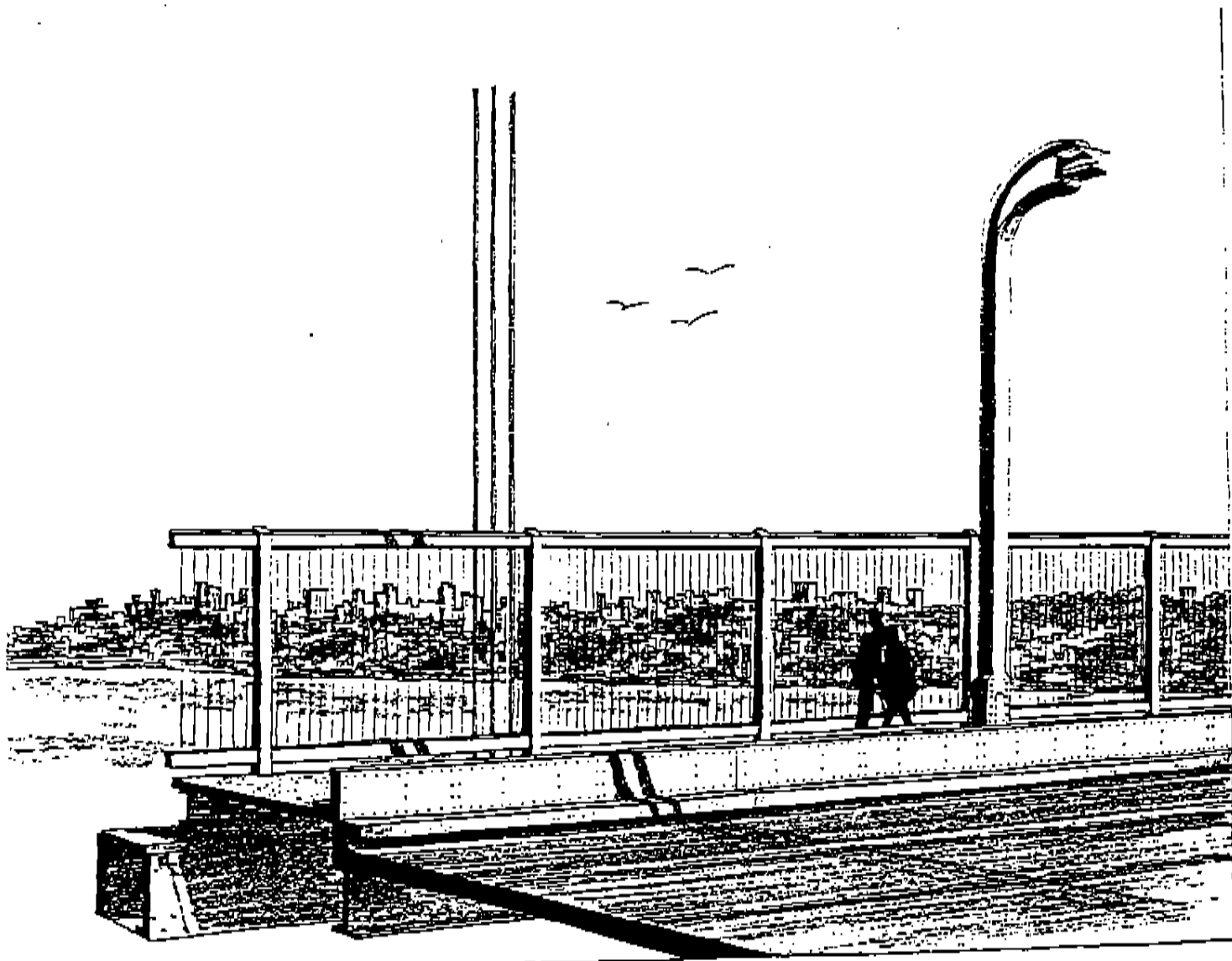

**7. 1971 ANSHEN & ALLEN PROPOSAL**

HIGH TENSION STEEL WIRES  
ON COLLAPSIBLE SECTION

TOP 2'-0" WHEN GRABBED WILL  
FALL INWARDS 1'-10" OVER  
PEDESTRIAN SIDEWALK

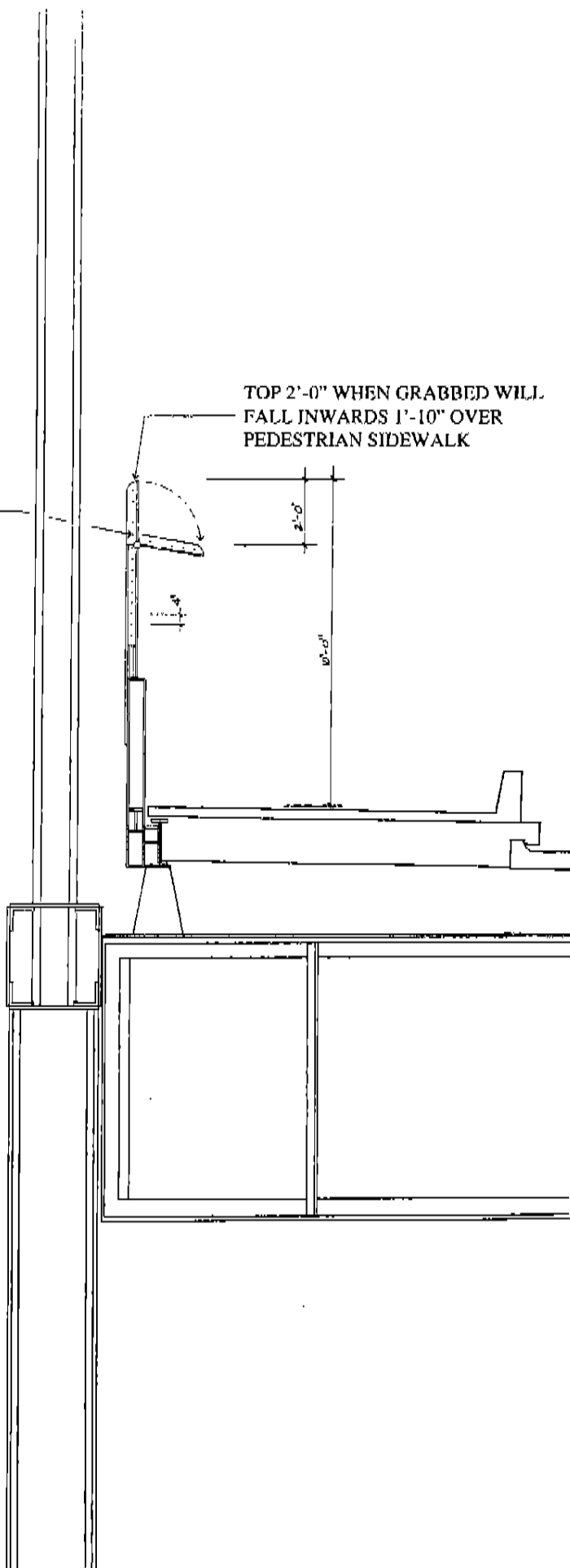

8. High Tension Wire with Hinge Post

SCALE 1/2" = 1'-0"